

PROJECT	DATE
TYPE	QTY.

WALL SERIES

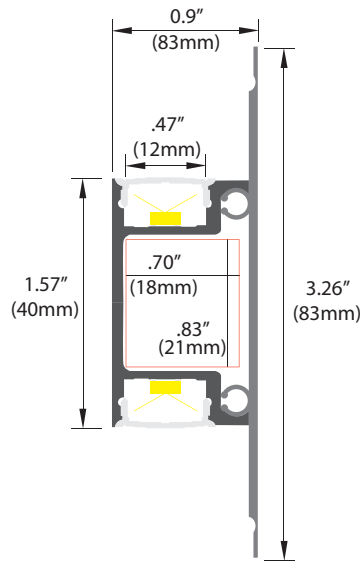

XTRU-AW4-1



X-TRU-AW4-1 LED Profile is designed for unique applications for designers and architects.

Suitable for surface mounting or custom recessed/mud-in installation. This high quality profile offers an unique way to make use of linear low voltage lighting and is the designer's choice for commercial and residential LED strip lighting.



The X-TRU-AW4 Aluminum Mounting Bracket is easily placed on horizontal or vertical surfaces and can be secured with aluminum screws or adhesive. (not included)

The X-TRU-AW4-1 Aluminum Mounting Channel is used to hold LED tape light and allows you to create your own custom LED low voltage lighting scheme.

Please note: These profiles are only compatible with strip light 0.4 inches wide or smaller. They are compatible with ThinGlow LED Strip Light.





ENDCAPS

- 4**  Aluminum Endcap w/ Hole
- 5**  Aluminum Endcap Closed

MUD FLANGE



- 1**  MALE CONNECTOR
- 2**  FEMALE CONNECTOR
- 3**  NO CONNECTOR

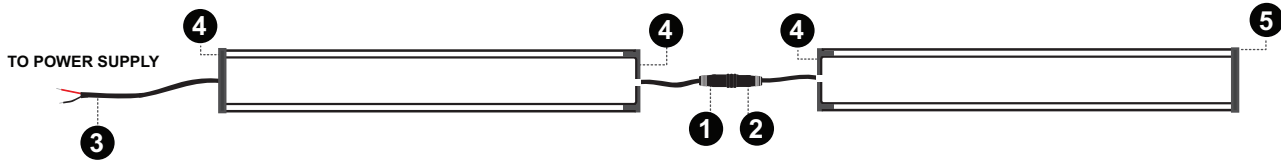

ORDERING Example:
XTRU-AW-4- 24\"

MODEL	CUT LENGTH	HOUSING FINISH	COVER	LED COLOR	LEAD WIRE LOCATION	LEAD WIRE LENGTH	END CAP
XTRU-AW-4 Aluminum LED Lighted Profile	<input type="text"/> Write desired length above	<input type="text"/> AA- Anodized Aluminum NA- Non-Anodized	<input type="text"/> F - Frosted C - Clear	<input type="text"/> WW - Warm White CW - Cool White NW - Neutral White RGB - Red, Greed, Blue	<input type="text"/> R - Right Facing L - Left Facing B - Left & Right* (daisy chain)	<input type="text"/> Write Desired Length Above	<input type="text"/> C - Closed H - Hole

X-LUME

A DIVISION OF IMPACT LIGHTING INC.

2101 West Central Blvd. Orlando, Florida 32805 USA • Phone: 1.800.507.5714 • Email: sales@impactlightinginc.com

www.xlumeled.com